

# OPERATING MANUAL

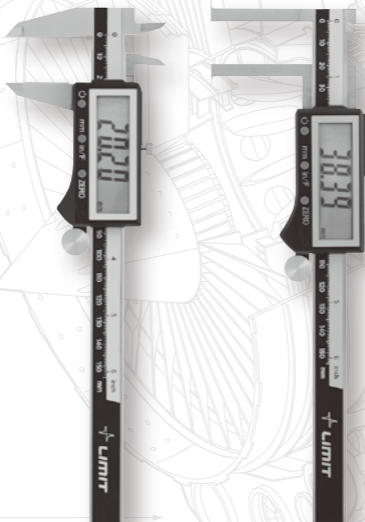

## Digital Caliper

Limit CDN 150 mm/200 mm/300 mm

Limit CDO 10-150 mm



English.....	2	GB
Svenska .....	4	SE
Norsk .....	6	NO
Dansk.....	8	DK
Suomi .....	10	FI
Deutsch .....	12	DE
Netherlands .....	14	NL
Français.....	16	FR
Italiano .....	18	IT
Español.....	20	ES
Português .....	22	PT
Polski .....	24	PL
Eesti .....	26	EE
Lietuviškai.....	28	LT
Latviski .....	30	LV

## OVERVIEW

Digital caliper with a big LCD display and 13 mm digits. Quick reading with 3.0 m/s response speed. Scale part in stainless steel. Absolut measurement and zero setting at any position, reading in mm or inch. Thumb roll included for self-installation. For measuring both inner diameter, outer diameter, depth and height, and with scribing function. Produced according to DIN 862.

## FEATURES

- Big LCD with 13 mm digits
- Hardened stainless steel
- CPU reading speed 3.0 m/s
- 4-function measurement
- Measuring units: mm, inch & frac in inch
- Zero setting at any position
- Thumb roll included (for self-installation)
- DIN 862

## SPECIFICATIONS

Model	150 mm	200 mm	300 mm	10-150 mm
Resolution	0.01 mm / 0.0005"			
Accuracy	0.02 mm	0.03 mm	0.04 mm	0.03 mm
Repeatability	±0.01 mm / 0.0005"			
Response speed	3.0 m/s	3.0 m/s	3.0 m/s	3.0 m/s
Operation temperature	0°C - 40°C	0°C - 40°C	0°C - 40°C	0°C - 40°C
Storage temperature	-20°C - 70°C	-20°C - 70 °C	-20°C - 70°C	-20°C - 70°C
Working humidity	<80%	<80%	<80%	<80%
Power supply	1 × 3 V CR 2032 lithium battery (included)			

## POSITIONS

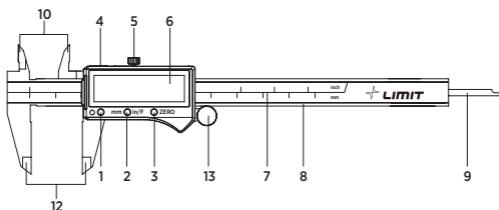

- |                  |                                |
|------------------|--------------------------------|
| 1. ON/OFF switch | 8. Beam                        |
| 2. mm/in switch  | 9. Depth measurement rod       |
| 3. Zero setting  | 10. Inner diameter measurement |
| 4. Battery lid   | 11. Height Measurement         |
| 5. Locking screw | 12. Outer diameter measurement |
| 6. LCD           | 13. Thumb roll (option)        |
| 7. Scale         |                                |

## FUNCTIONS

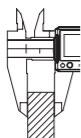

1

Outer diameter

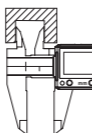

2

Inner diameter



3

Depth

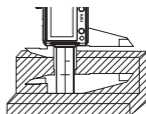

4

Height

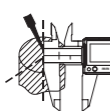

5

Scribing

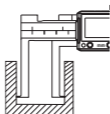

6

 Inner diameter  
(Limit CDO)

## BATTERY REPLACEMENT

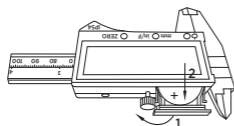

**Note:** Remove battery if not use the caliper for long time.

## TROUBLE SHOOTING

Problem	Possible causes	Solution
Flashing digits	Low voltage	Replace the battery
No display	1. Low voltage 2. Poor contact	1. Replace the battery 2. Clean the battery and battery seat. Make sure + is upside
Fixed digits	Accidental trouble in circuit.	Take out battery and replace it after 2 minutes.

## ÖVERSIKT

Digitalt skjutmått med stor LCD-display och 13 mm höga siffror. Snabb avläsning (avläsningshastighet 3,0 m/s). Skala i rostfritt stål. Absolut mätning och nollställning i valfritt läge (avläsning i mm eller tum). Tumrulle (medföljer, ej installerad) För mätning av invändig diameter, utvändig diameter, djup och höjd samt med ritsfunktion. Tillverkat enligt DIN 862.

## EGENSKAPER

- Stor LCD-display med 13 mm höga siffror
- Härdat rostfritt stål
- Avläsningshastighet för processor: 3,0 m/s
- Fyra olika mätfunktioner
- Måttenheter: mm, tum ((tum både med decimaler och som fraktion))
- Nollställning i valfritt läge
- Tumrulle (medföljer, ej installerad)
- DIN 862

## SPECIFIKATIONER

Modell	150 mm	200 mm	300 mm	10-150 mm
Upplösning	0,01 mm / 0,0005 tum			
Noggrannhet	0,02 mm	0,03 mm	0,04 mm	0,03 mm
Repeterbarhet	±0,01 mm / 0,0005 tum			
Avläsningshastighet	3,0 m/s	3,0 m/s	3,0 m/s	3,0 m/s
Drifttemperatur	0°C till 40°C	0°C till 40°C	0°C till 40°C	0°C till 40°C
Förvaringstemperatur	-20°C till 70°C	-20°C till 70°C	-20°C till 70°C	-20°C till 70°C
Driftfuktighet	<80%	<80%	<80%	<80%
Strömförsörjning	1× 3 V CR 2032 Litium (medföljer)			

## LÄGEN

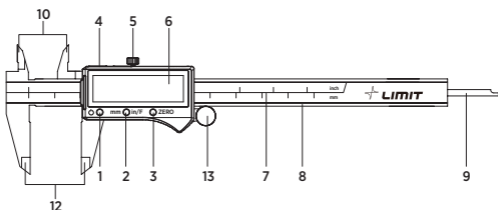

- |                          |                                  |
|--------------------------|----------------------------------|
| 1. Strömbrytare (ON/OFF) | 8. Skena                         |
| 2. Omkopplare mm/tum     | 9. Djupmätningssicka             |
| 3. Nollställning         | 10. Mätning av invändig diameter |
| 4. Batterilock           | 11. Höjdmätning                  |
| 5. Låsskruv              | 12. Mätning av utvändig diameter |
| 6. LCD-DISPLAY           | 13. Tumrulle (tillval)           |
| 7. Huvudskala            |                                  |

## FUNKTIONER

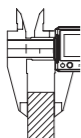

1

Utvändig diameter

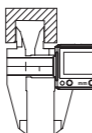

2

Invändig diameter



3

Djup

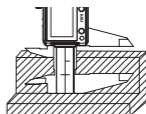

4

Höjd

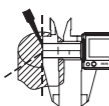

5

Ritsning

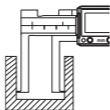

6

Invändig diameter  
(Limit CDO)

SE

## BATTERIBYTE

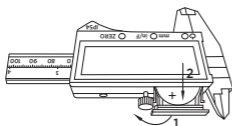

**OBS!** Ta ut batteriet om du inte ska använda skjutmättet under en längre tid.

## FELSÖKNING

Problem	Möjlig orsak	Lösning
Siffrorna blinkar	Låg spänning	Byt batteriet
Inga siffror visas på displayen	1. Låg spänning 2. Dålig kontakt	1. Byt batteriet 2. Rengör batteriet och batteriläget. Försäkra dig om att (+) är vänt uppåt
Siffrorna lyser med fast sken	Fel i kretsen	Ta ut batteriet och vänta 2 minuter. Sätt i batteriet igen

## OVERSIKT

Digital skyvelære med stort LCD-display og 13 mm sifre. Rask måling med en responshastighet på 3,0 m/s. Skaladel i rustfritt stål. Absolutt måling og nullstilling i alle posisjoner, måleverdi i mm eller tommer. Tommelhjul for egenmontering inkludert. Til måling av både indre diameter, ytre diameter, dybde og høyde, og med rissefunksjon. Produsert i samsvar med DIN 862.

## EGENSKAPER

- Stort LCD-display med 13 mm sifre
- Herdet rustfritt stål
- Prosessorens avlesningshastighet er 3,0 m/s
- 4 målefunksjoner
- Måleenheter: millimeter, tommer og brøkdeler av en tomme
- Nullstilling i alle posisjoner
- Tommelhjul (for egenmontering) inkludert
- DIN 862

## SPESIFIKASJONER

Modell	150 mm	200 mm	300 mm	10-150 mm
Oppløsning	0,01 mm / 0,0005 tommer			
Nøyaktighet	0,02 mm	0,03 mm	0,04 mm	0,03 mm
Repeterbarhet	±0,01 mm / 0,0005 tommer			
Responshastighet	3,0 m/s	3,0 m/s	3,0 m/s	3,0 m/s
Brukstemperatur	0°C - 40°C	0°C - 40°C	0°C - 40°C	0°C - 40°C
Oppbevaringstemperatur	-20°C - 70°C	-20°C - 70°C	-20°C - 70°C	-20°C - 70°C
Arbeidsfuktighet	<80%	<80%	<80%	<80%
Strømtilførsel	1×3 V CR 2032 litiumbatteri, inkludert			

## POSISJONER

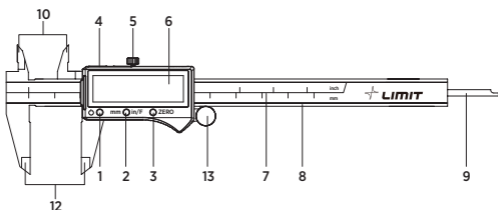

1. Av/på-bryter
2. Bryter for mm/tommer
3. Nullstilling
4. Batterideksel
5. Låseskrue
6. LCD-display
7. Skala
8. Stråle
9. Dydbemålingsstang
10. Måling av indre diameter
11. Høydemåling
12. Måling av ytre diameter
13. Tommelhjul (tilvalg)



## FUNKSJONER

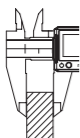

1  
Ytre diameter

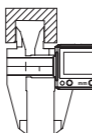

2  
Indre diameter



3  
Dybde

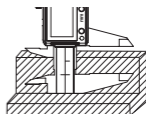

4  
Høyde

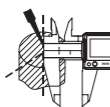

5  
Rissing

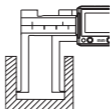

6  
Indre diameter  
(Limit CDO)

NO

## SKIFTE BATTERI

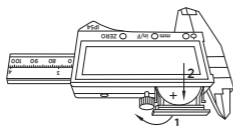

**Merk:** Ta ut batteriet hvis skyvelæren ikke skal brukes i lengre tid.

## FELSÖKNING

Problem	Mulige årsaker	Løsning
Tallene blinker	Lav spenning	Skift batteriet
Ingenting vises	1. Lav spenning 2. Dårlig kontakt	1. Skift batteriet 2. Rengjør batteriet og batterirommet. Påse at + venter opp
Fastfrosne tall	Sporadisk kretsfeil	Ta ut batteriet og sett det inn igjen etter 2 minutter

## OVERSIGT

Digital skydelære med et stort LCD-display og 13 mm cifre. Lynaflysning med responstid på 3,0 m/s. Skaladel af rustfrit stål. Absolut måling og nulstilling i alle positioner, aflæsning i mm eller tommer. Tommelbetjent rulleknop medfølger til egeninstallation. Til måling af både indvendig diameter, udvendig diameter, dybde og højde samt med ridsefunktion. Fremstillet iht. DIN 862.

## EGENSKABER

- Stort LCD med 13 mm cifre
- Hærdet rustfrit stål
- CPU-målehastighed 3,0 m/s
- 4-funktionsmåling
- Måleenheder: mm, tommerogfrak. i tommer
- Nulstilling i alle positioner
- Tommelbetjent rulleknop medfølger (til egeninstallation)
- DIN 862

## SPECIFIKATIONER

Model	150 mm	200 mm	300 mm	10-150 mm
Opløsning	0,01 mm / 0,0005 tomme			
Nøjagtighed	0,02 mm	0,03 mm	0,04 mm	0,03 mm
Gentagelsesnøjagtighed	±0,01 mm / 0,0005 tomme			
Responshastighed	3,0 m/s	3,0 m/s	3,0 m/s	3,0 m/s
Driftstemperatur	0°C - 40°C	0°C - 40°C	0°C - 40°C	0°C - 40°C
Opbevaringstemperatur	-20°C - 70°C	-20°C - 70°C	-20°C - 70°C	-20°C - 70°C
Driftsfugtighed	<80%	<80%	<80%	<80%
Strømforsyning	1×3 V CR 2032 Lithium, medfølger			

## INDSTILLINGER

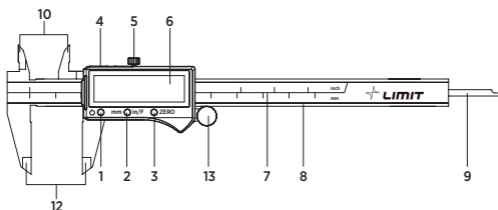

- |                                      |  |
|--------------------------------------|--|
| 1. Tænd-/sluk-knap                   | 8. Kant                                |
| 2. Knap til skift mellem mm og tomme | 9. Stang til måling af dybde           |
| 3. Nulstilling                       | 10. Måling af indvendig diameter       |
| 4. Batteridæksel                     | 11. Måling af højde                    |
| 5. Låseskrue                         | 12. Måling af udvendig diameter        |
| 6. LCD                               | 13. Tommelbetjent rulleknop (tilbehør) |
| 7. Skala                             |  |

## FUNKTIONER

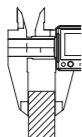

1

Udvendig diameter

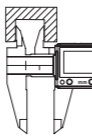

2

Indvendig diameter



3

Dybde

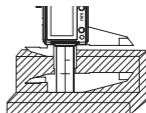

4

Højde

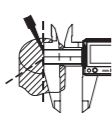

5

Skrivning

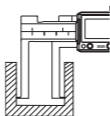

6

Indvendig diameter  
(Limit CDO)

## UDSKIFTNING AF BATTERI

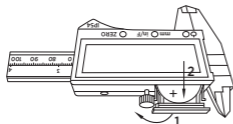

**Bemærk:** Fjern batteriet, hvis skydelæren ikke bruges i længere tid.

## FEJLFINDING

Problem	Mulige årsager	Løsning
Blinkende cifre	Lav spænding	Udskift batteriet
Ingen visning	1. Lav spænding 2. Ringe kontakt	1. Udskift batteriet 2. Rengør batteriet og batterirummet. Kontrollér, at + vender opad
Cifrene skifter ikke	Midlertidig kredsløbsfejl	Tag batteriet ud, og isæt det igen efter 2 minutter

## YLEISTÄ

Digitaalinen työntömitta, jossa suuri LCD-näyttö ja 13 mm numerot. Nopea luku 3,0 m/s vasteajalla. Asteikko ruostumatonta terästä. Absoluuttinen arvo ja nollakohdan asetus kaikissa asennoissa, mittausravon näyttö millimetreinä tai tuumina. Mukana kierrettävä säädin asetusta varten. Mittaa sisä- ja ulkopuolisen läpimitan, syvyyden ja korkeuden, lisäksi merkintätoiminto. Valmistusstandardi DIN 862.

## OMINAISUUDET

- Suuri LCD-näyttö 13 mm numeroin
- Karkaistua ruostumatonta terästä
- CPU-lukunopeus 3,0 m/s
- 4 mittaustoimintoa
- Mittayksiköt: mm, tuuma ja tuuma murtolukuna
- Nollakohdan asettaminen kaikissa asennoissa
- Mukana kierrettävä säädin (asetusta varten)
- DIN 862

FI

## TEKNISET TIEDOT

Malli	150 mm	200 mm	300 mm	10-150 mm
Erottelutarkkuus	0,01 mm / 0,0005 tuumaa			
Tarkkuus	0,02 mm	0,03 mm	0,04 mm	0,03 mm
Toistettavuus	±0,01 mm / 0,0005 tuumaa			
Vasteaika	3,0 m/s	3,0 m/s	3,0 m/s	3,0 m/s
Käyttölämpötila	0°C - 40°C	0°C - 40°C	0°C - 40°C	0°C - 40°C
Säilytyslämpötila	-20°C - 70°C	-20°C - 70°C	-20°C - 70°C	-20°C - 70°C
Käyttöympäristön kosteus	<80%	<80%	<80%	<80%
Virtalähde	1 × 3 V CR 2032 litium, sisältyy			

## LAITTEEN OSAT

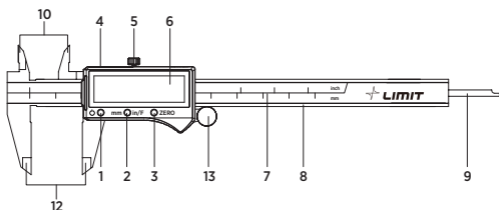

- |                             |                                      |
|-----------------------------|--------------------------------------|
| 1. ON/OFF-kytkin            | 8. Varsi                             |
| 2. Asteikon vaihto mm/tuuma | 9. Syvyydsmittauspuikko              |
| 3. Nollaus                  | 10. Sisäläpimitan mittaus            |
| 4. Paristokotelon kansi     | 11. Korkeuden mittaus                |
| 5. Lukitusruuvi             | 12. Ulkoläpimitan mittaus            |
| 6. LCD-näyttö               | 13. Kierrettävä säädin (valinnainen) |
| 7. Asteikko                 |                                      |

## TOIMINNOT

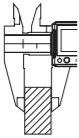

1  
Ulkolämpimitta

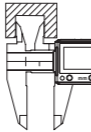

2  
Sisälämpimitta



3  
Syvyys

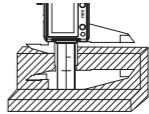

4  
Korkeus

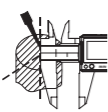

5  
Merkintä

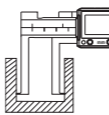

6  
Sisälämpimitta  
(Limit CDO)

FI

## PARISTON VAIHTAMINEN

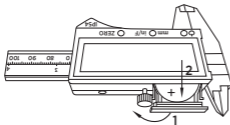

Huom! Ota paristo pois, mikäli mittaria ei käytetä pitkään aikaan.

## VIANMÄÄRITYS

Ongelma	Mahdollinen syy	Ratkaisu
Numerot vilkkuvat	Alhainen jännite	Vaihda paristo
Näyttö ei toimi	1. Alhainen jännite 2. Huono kosketus	1. Vaihda paristo 2. Puhdista paristo ja laitteen liitin. Varmista, että +-napa on ylöspäin
Numerot ovat jumiutuneet	Ongelma virtapiirissä	Ota paristo pois ja asenna se takaisin 2 minuutin kuluttua

## ÜBERSICHT

Digitaler Messschieber mit großem LCD-Display und 13 mm großen Zeichen. Schnelle Ablesung mit 3,0 m/s Reaktionsgeschwindigkeit. Skalenteil aus Edelstahl. Absolute Messung und Nullpunkteinstellung an jeder Position, Ablesung in mm oder Inch. Daumenrolle für Selbstinstallation vorhanden. Für die Messung von Innendurchmesser, Außendurchmesser, Tiefe und Höhe und mit Anreiß-Funktion. Hergestellt gemäß DIN 862.

## EIGENSCHAFTEN

- Großes LCD mit 13-mm-Ziffern
- Gehärteter Edelstahl
- CPU-Lesegeschwindigkeit 3,0 m/s
- 4-Funktionen-Messung
- Maßeinheiten: mm, Inch & teilmaße in Inch
- Nullpunkteinstellung an jeder Position
- Daumenrolle (für Selbstinstallation) vorhanden
- DIN 862

## SPEZIFIKATIONEN

Modell	150 mm	200 mm	300 mm	10-150 mm
Auflösung	0,01 mm / 0,0005"			
Messgenauigkeit	0,02 mm	0,03 mm	0,04 mm	0,03 mm
Wiederholgenauigkeit	±0,01 mm / 0,0005"			
Reaktionsgeschwindigkeit	3,0 m/s	3,0 m/s	3,0 m/s	3,0 m/s
Betriebstemperatur	0°C - 40°C	0°C - 40°C	0°C - 40°C	0°C - 40°C
Lagertemperatur	-20°C - 70°C	-20°C - 70°C	-20°C - 70°C	-20°C - 70°C
Feuchtigkeit im Arbeitsbereich	<80%	<80%	<80%	<80%
Stromversorgung	1×3 V CR 2032 Lithium, enthalten			

## POSITIONEN

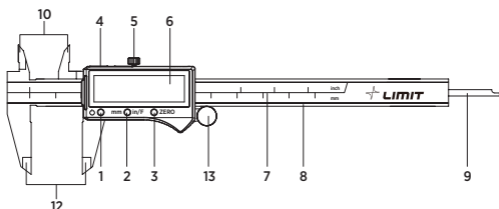

- |                         |                             |
|-------------------------|-----------------------------|
| 1. EIN/AUS-Schalter     | 8. Strahl                   |
| 2. mm/Inch-Schalter     | 9. Tiefenmessstange         |
| 3. Nullpunkteinstellung | 10. Innendurchmessermessung |
| 4. Batteriefach         | 11. Höhenmessung            |
| 5. Feststellschraube    | 12. Außendurchmessermessung |
| 6. LCD                  | 13. Daumenrolle (optional)  |
| 7. Skala                |                             |

## FUNKTIONEN

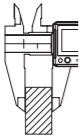

1

Außendurchmesser

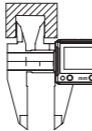

2

Innendurchmesser



3

Tiefe

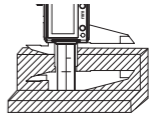

4

Höhe

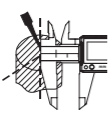

5

Anreißfunktion

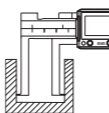

6

Innendurchmesser  
(Limit CDO)

DE

## AUSTAUSCHEN DER BATTERIEN

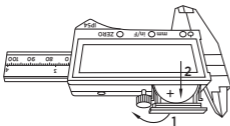

**Hinweis:** Entfernen sie die batterie, wenn sie den messschieber längere zeit nicht verwenden.

## FEHLERBEHEBUNG

Problem	Mögliche ursachen	Lösung
Blinkende ziffern	Geringe spannung	Batterie austauschen
Keine anzeige	1. Geringe spannung 2. Schlechter kontakt	1. Batterie austauschen 2. Batterie und batteriekontakte reinigen. sicherstellen, dass + oben ist
Feststehende ziffern	Vorübergehendes Problem im schaltkreis	Batterie herausnehmen und nach 2 Minuten wieder einsetzen

## OVERZICHT

Digitale schuifmaat met groot LCD en cijfers van 13 mm. Snel aflezen met 3,0 m/s reactiesnelheid Meetgedeelte van roestvrijstaal. Absolute metingen en nulinstelling in iedere positie, meetwaarde in mm of inch. Inclusief duimrol voor zelfinstallatie. Voor het meten van zowel binnenmaten, buitenmaten, diepte en hoogte, en met graveerfunctie. Gefabriceerd conform DIN 862.

## KENMERKEN

- Groot LCD met cijfers van 13 mm
- Gehard roestvrijstaal
- CPU-leessnelheid 3,0 m/s
- Meting met 4 functies
- Meeteenheden: mm, inch & frac in inch
- Nulinstelling in iedere positie
- Inclusief duimrol (voor zelfinstallatie)
- DIN 862

## SPECIFICATIES

Model	150 mm	200 mm	300 mm	10-150 mm
Resolutie	0,01 mm / 0,0005"			
Nauwkeurigheid	0,02 mm	0,03 mm	0,04 mm	0,03 mm
Reproduceerbaarheid	±0,01 mm / 0,0005"			
Reactiesnelheid	3,0 m/s	3,0 m/s	3,0 m/s	3,0 m/s
Bedrijfstemperatuur	0°C - 40°C	0°C - 40°C	0°C - 40°C	0°C - 40°C
Opslagtemperatuur	-20°C - 70°C	-20°C - 70°C	-20°C - 70°C	-20°C - 70°C
Werkvochtigheid	<80%	<80%	<80%	<80%
Voeding	1 × 3 V CR 2032 Lithium, bijgeleverd			

## OVERZICHT

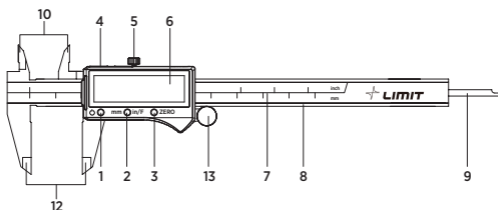

- |                       |                       |
|-----------------------|-----------------------|
| 1. AAN/UIT-schakelaar | 8. Liniaal            |
| 2. Schakelaar mm/in   | 9. Dieptemaat         |
| 3. Nulinstelling      | 10. Meting binnenmaat |
| 4. Batterijklepje     | 11. Hoogtemeting      |
| 5. Borgschroef        | 12. Meting buitenmaat |
| 6. LCD                | 13. Duimrol (optie)   |
| 7. Schaal             |                       |



## FUNCTIES

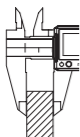

1  
Buitenmaat

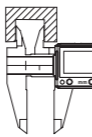

2  
Binnenmaat



3  
Diepte

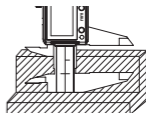

4  
Hoogte

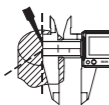

5  
Gravenen

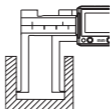

6  
Binnenmaat  
(Limit CDO)

NL

## BATTERIJ VERVANGEN

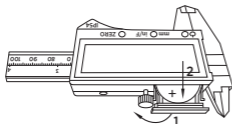

**Opmerking:** Verwijder de batterij als de schuifmaat langere tijd niet wordt gebruikt.

## PROBLEEMOPLOSSING

Probleem	Mogelijke oorzaken	Oplossing
Knipperende cijfers	Lage batterijspanning	Batterij vervangen
Geen display	1. Lage batterijspanning 2. Slecht contact	1. Batterij vervangen 2. Reinig de batterij en het batterijcompartiment. Zorg dat de + kant naar boven is gericht
Cijfers vastgelopen	Tijdelijk probleem in circuit	Verwijder de batterij en plaats deze na 2 minuten terug

## PRÉSENTATION GÉNÉRALE

Pied à coulisse numérique avec grand écran LCD et chiffres de 13 mm. Lecture rapide avec vitesse de réponse de 3,0 m/s. La partie graduée est en acier inoxydable. Mesure absolue et réglage du zéro sur n'importe quelle position, lecture en mm ou en pouces. Molette incluse pour auto-installation. Pour mesure de diamètre intérieur et extérieur, profondeur et hauteur, avec fonction de marquage. Fabriqué selon DIN 862.

## FONCTIONNALITÉS

- Grand écran LCD avec chiffres de 13 mm
- Acier inoxydable trempé
- Vitesse de lecture du processeur de 3,0 m/s
- Mesure à 4 fonctions
- Unités de mesure : mm, pouces & fraction de pouce
- Réglage du zéro sur n'importe quelle position
- Molette incluse (pour auto-installation)
- DIN 862

## CARACTÉRISTIQUES

Modèle	150 mm	200 mm	300 mm	10-150 mm
Résolution	0,01 mm / 0,0005 pouce			
Précision	0,02 mm	0,03 mm	0,04 mm	0,03 mm
Reproductibilité	±0,01 mm / 0,0005 pouce			
Vitesse de réponse	3,0 m/s	3,0 m/s	3,0 m/s	3,0 m/s
Température d'utilisation	0°C - 40°C	0°C - 40°C	0°C - 40°C	0°C - 40°C
Température de stockage	-20°C - 70°C	-20°C - 70°C	-20°C - 70°C	-20°C - 70°C
Humidité en service	<80%	<80%	<80%	<80%
Alimentation électrique	1 × 3 V CR 2032 Lithium, incluse			

FR

## POSITIONS

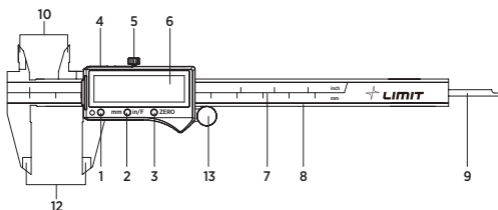

- |                             |                                  |
|-----------------------------|----------------------------------|
| 1. Commutateur Marche/Arrêt | 8. Barre                         |
| 2. Commutateur mm/pouces    | 9. Tige de mesure de profondeur  |
| 3. Réglage du Zéro          | 10. Mesure du diamètre intérieur |
| 4. Couvercle de pile        | 11. Mesure en hauteur            |
| 5. Vis de blocage           | 12. Mesure du diamètre extérieur |
| 6. LCD                      | 13. Molette (option)             |
| 7. Échelle                  |                                  |

## FONCTIONS

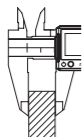

1

Diamètre extérieur

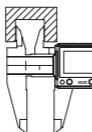

2

Diamètre intérieur



3

Profondeur

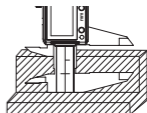

4

Hauteur

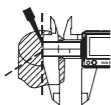

5

Marquage

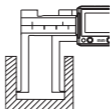

6

Diamètre intérieur  
(Limit CDO)

## REPLACEMENT DE LA PILE

FR

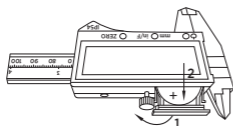

**Remarque:** Retirer la pile si le pied à coulisse n'est pas utilisé pendant une longue période.

## DÉTECTION DES PANNES

Problème	Causes possibles	Solution
Chiffres clignotants	Basse tension	Remplacer la pile
Rien à l'écran	1. Basse tension 2. Mauvais contact	1. Remplacer la pile 2. Nettoyer les contacts et le logement de la pile. S'assurer que le + est tourné vers le haut
Chiffres fixes	Problème accidentel dans le circuit	Retirer la pile et la remplacer au bout de 2 minutes

## PRESENTAZIONE

Calibro digitale con ampio display LCD con cifre da 13 mm. Lettura immediata con velocità di risposta di 3,0 m/s. Parte della scala in acciaio inox. Misurazione assoluta e azzeramento in qualsiasi posizione, lettura in mm o pollici. Rullo per il pollice incluso per l'autoinstallazione. Per la misurazione di diametro interno, diametro esterno, profondità e altezza, con funzione di tracciatura. Conformità alla norma DIN 862.

## CARATTERISTICHE

- Ampio display LCD con cifre da 13 mm
- Acciaio inox temprato
- CPU con velocità di lettura di 3,0 m/s
- 4 funzioni di misurazione
- Unità di misura: mm, pollici e frazioni di pollici
- Azzeramento in qualsiasi posizione
- Rullo per il pollice incluso (per l'autoinstallazione).
- DIN 862

## SPECIFICHE

Modello	150 mm	200 mm	300 mm	10-150 mm
Risoluzione	0,01 mm / 0,0005 pollici			
Precisione	0,02 mm	0,03 mm	0,04 mm	0,03 mm
Ripetibilità	±0,01 mm / 0,0005 pollici			
Velocità di risposta	3,0 m/s	3,0 m/s	3,0 m/s	3,0 m/s
Temperatura di esercizio	0°C - 40°C	0°C - 40°C	0°C - 40°C	0°C - 40°C
Temperatura di immagazzinaggio	-20°C - 70°C	-20°C - 70°C	-20°C - 70°C	-20°C - 70°C
Umidità di esercizio	<80%	<80%	<80%	<80%
Alimentazione	1×3 V CR 2032 Batteria al litio, inclusa			

IT

## POSIZIONI

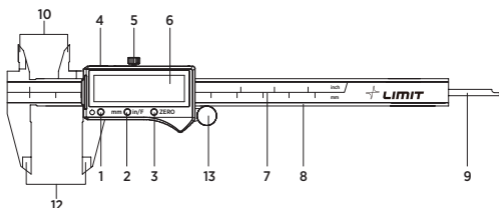

- |                         |   |
|-------------------------|---|
| 1. Interruttore ON/OFF  | 8. Raggio                               |
| 2. Selettore mm/pollici | 9. Asta di misurazione della profondità |
| 3. Azzeramento          | 10. Misurazione del diametro interno    |
| 4. Vano batteria        | 11. Misurazione dell'altezza            |
| 5. Vite di bloccaggio   | 12. Misurazione del diametro esterno    |
| 6. LCD                  | 13. Rullo per il pollice (opzionale)    |
| 7. Scala                |   |

## FUNZIONI

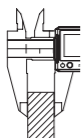

1

Diametro esterno

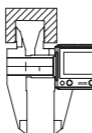

2

Diametro interno



3

Profondità

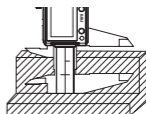

4

Altezza

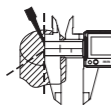

5

Tracciatura

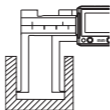

6

Diametro interno  
(Limit CDO)

## SOSTITUZIONE DELLA BATTERIA

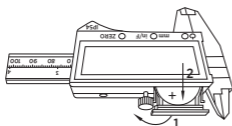

**Nota:** Rimuovere la batteria in caso di inutilizzo prolungato del calibro.

## RICERCA DEI GUASTI

Problema	Possibili cause	Soluzione
Cifre lampeggianti	Bassa tensione	Sostituire la batteria
Display spento	1. Bassa tensione 2. Contatto insufficiente	1. Sostituire la batteria 2. Pulire la batteria e la relativa sede. Accertarsi che il lato + sia rivolto verso l'alto
Cifre fisse	Guasto accidentale nel circuito	Estrarre la batteria, attendere 2 minuti e reinserirla

## SINOPSIS

Calibre digital con display LCD grande y dígitos de 13 mm. Lectura rápida con velocidad de respuesta de 3,0 m/s. Parte de escala de acero inoxidable. Medición absoluta y puesta a cero en cualquier posición. Lectura en mm o pulgadas. Rodillo de pulgar opcional. Para medir diámetro interior y exterior, profundidad y altura. Con función de rayado. Fabricado según la norma DIN 862.

## CARACTERÍSTICAS

- Display LCD grande con dígitos de 13 mm
- Acero templado inoxidable
- Velocidad de lectura de CPU, 3,0 m/s
- Medición de 4 funciones
- Unidades de medición: mm y pulgadas & fracción de pulgada
- Puesta a cero en cualquier posición
- Rodillo de pulgar opcional
- DIN 862

## ESPECIFICACIONES

Modelo	150 mm	200 mm	300 mm	10-150 mm
Resolución	0,01 mm / 0,0005 pulgadas			
Precisión	0,02 mm	0,03 mm	0,04 mm	0,03 mm
Repetibilidad	±0,01 mm / 0,0005 pulgadas			
Velocidad de respuesta	3,0 m/s	3,0 m/s	3,0 m/s	3,0 m/s
Temperatura de funcionamiento	0°C - 40°C	0°C - 40°C	0°C - 40°C	0°C - 40°C
Temperatura de almacenaje	-20°C - 70°C	-20°C - 70°C	-20°C - 70°C	-20°C - 70°C
Humedad de trabajo	<80%	<80%	<80%	<80%
Fuente de alimentación	1×3 V CR 2032 Litio, incluida			

## POSICIONES

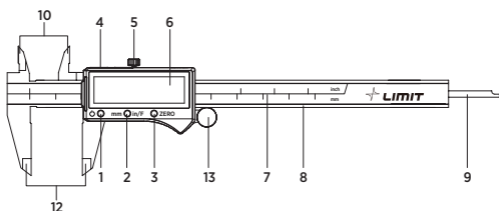

- |                                     |                                     |
|-------------------------------------|-------------------------------------|
| 1. Interruptor de encendido/apagado | 8. Rayo                             |
| 2. Conmutador mm/pulgadas           | 9. Barra de medición de profundidad |
| 3. Puesta a cero                    | 10. Medición de diámetro interior   |
| 4. Tapa de pila                     | 11. Medición de altura              |
| 5. Tornillo de fijación             | 12. Medición de diámetro exterior   |
| 6. LCD                              | 13. Rodillo de pulgar (opcional)    |
| 7. Escala                           |                                     |

## MANEJO

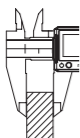

1

Diámetro exterior

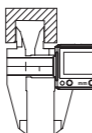

2

Diámetro interior



3

Profundidad

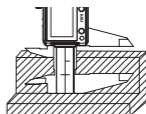

4

Altura

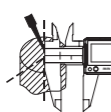

5

Rayado

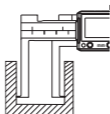

6

Diámetro interior  
(Limit CDO)

## CAMBIO DE LA PILA

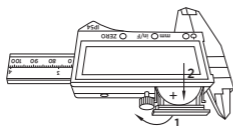

ES

**Nota:** Quitar la pila si el calibre no se va a usar por largo tiempo.

## RESOLUCIÓN DE PROBLEMAS

Problema	Causas posibles	Solución
Dígitos destellantes	Voltaje bajo	Cambiar la pila
No hay visualización	1. Voltaje bajo 2. Mal contacto	1. Cambiar la pila 2. Limpiar la pila y el asiento de la misma. Comprobar que el signo + está arriba
Dígitos fijos	Defecto accidental en circuito	Sacar la pila y recolocarla después de 2 minutos

## DESCRIÇÃO GERAL

Paquímetro digital com um visor LCD grande e dígitos de 13 mm. Leitura rápida com velocidade de resposta de 3,0 m/s. Secção de escala em aço inoxidável. Medição absoluta e definição zero em qualquer posição, leitura em mm ou polegadas. Rolete de polegar incluído para instalação automática. Para medir os diâmetros interno e externo, a profundidade e a altura; inclui a função de traçagem. Fabricado de acordo com a DIN 862.

## CARACTERÍSTICAS

- LCD grande com dígitos de 13 mm
- Aço inoxidável endurecido
- Velocidade de leitura da CPU de 3,0 m/s
- Medição com 4 funções
- Unidades de medição: milímetro, polegada e fração de polegada
- Definição zero em qualquer posição
- Rolete de polegar incluído (para instalação automática)
- DIN 862

## ESPECIFICAÇÕES

Modelo	150 mm	200 mm	300 mm	10-150 mm
Resolução	0,01 mm / 0,0005 pol.			
Precisão	0,02 mm	0,03 mm	0,04 mm	0,03 mm
Repetibilidade	±0,01 mm / 0,0005 pol.			
Velocidade de resposta	3,0 m/s	3,0 m/s	3,0 m/s	3,0 m/s
Temperatura operacional	0°C - 40°C	0°C - 40°C	0°C - 40°C	0°C - 40°C
Temperatura de armazenamento	-20°C - 70°C	-20°C - 70°C	-20°C - 70°C	-20°C - 70°C
Humidade de funcionamento	<80%	<80%	<80%	<80%
Fonte de alimentação	1× 3 V CR 2032 Lítio, incluído			

## POSIÇÕES

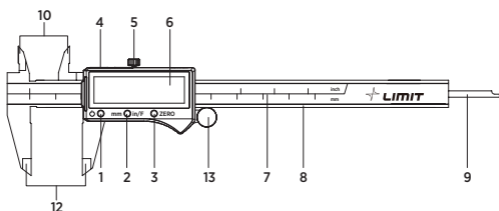

- |   |                                     |
|---|-------------------------------------|
| 1. Comutação de ligar/desligar (ON/OFF) | 8. Feixe                            |
| 2. Comutação de mm/pol.                 | 9. Haste de medição de profundidade |
| 3. Definição zero                       | 10. Medição de diâmetro interior    |
| 4. Tampa da bateria                     | 11. Medição de altura               |
| 5. Parafuso de bloqueio                 | 12. Medição de diâmetro exterior    |
| 6. LCD                                  | 13. Rolete de polegar (opção)       |
| 7. Escala                               |                                     |



## FUNÇÕES

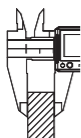

1

Diâmetro exterior

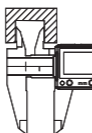

2

Diâmetro interior



3

Profundidade

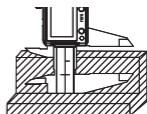

4

Altura

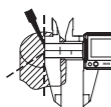

5

Traçagem

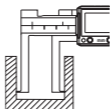

6

Diâmetro interior  
(Limit CDO)

## SUBSTITUIÇÃO DA BATERIA

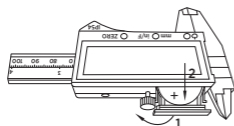

**Nota:** Remova a bateria se não utilizar o paquímetro durante muito tempo.

## RESOLUÇÃO DE PROBLEMAS

Problema	Causas possíveis	Solução
Dígitos intermitentes	Baixa tensão	Substitua a bateria
Sem imagem no visor	1. Baixa tensão 2. Mau contacto	1. Substitua a bateria 2. Limpe a bateria e a respetiva base de suporte. Certifique-se de que o símbolo + está virado para cima
Dígitos fixos	Falha acidental no circuito	Retire a bateria e volte a colocá-la 2 minutos depois

## OPIS OGÓLNY

Suwmiarka cyfrowa z dużym wyświetlaczem LCD i cyframi o wysokości 13 mm. Szybki pomiar – szybkość reakcji 3,0 m/s. Część z podziałką wykonana ze stali nierdzewnej. Pomiar bezwzględny oraz zerowanie w dowolnej pozycji, wskazanie w mm lub calach. W załączeniu rolka pod kciuk – do samodzielnej instalacji. Do pomiarów średnicy wewnętrznej, średnicy zewnętrznej, głębokości i wysokości, ponadto funkcja trasowania. Wykonanie zgodne z normą DIN 862.

## CECHY CHARAKTERYSTYCZNE

- Duże cyfry LCD, wysokość 13 mm
- Utwardzana stal nierdzewna
- Szybkość odczytu procesora 3,0 m/s
- 4 funkcje pomiarowe
- Jednostki miary: mm, cale ułamki calowe
- Zerowanie w dowolnej pozycji
- W załączeniu rolka pod kciuk (do samodzielnej instalacji)
- DIN 862

## DANE TECHNICZNE

Model	150 mm	200 mm	300 mm	10-150 mm
Rozdzielczość	0,01 mm / 0,0005"			
Dokładność pomiaru	0,02 mm	0,03 mm	0,04 mm	0,03 mm
Powtarzalność	±0,01 mm / 0,0005"			
Szybkość reakcji	3,0 m/s	3,0 m/s	3,0 m/s	3,0 m/s
Temperatura pracy	od 0 do 40°C	od 0 do 40°C	od 0 do 40°C	od 0 do 40°C
Temperatura przechowywania	od -20 do 70°C	od -20 do 70°C	od -20 do 70°C	od -20 do 70°C
Wilgotność powietrza	<80%	<80%	<80%	<80%
Zasilanie	1×3 V CR 2032 bat. litowa, w załączeniu			

## OPIS ZEWNĘTRZNY

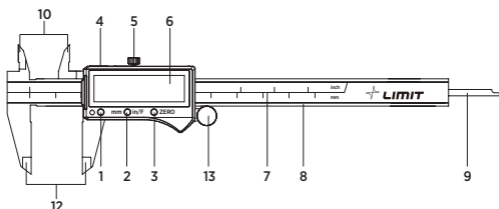

- |                       |                                 |
|-----------------------|---------------------------------|
| 1. Wyłącznik ON/OFF   | 8. Prowadnica                   |
| 2. Przełącznik mm/cal | 9. Wysuwka głębokościomierza    |
| 3. Ustawianie zera    | 10. Pomiar średnicy wewnętrznej |
| 4. Przykrywka baterii | 11. Pomiar wysokości            |
| 5. Śruba zaciskowa    | 12. Pomiar średnicy zewnętrznej |
| 6. Wyświetlacz LCD    | 13. Rolka pod kciuk (opcja)     |
| 7. Podziałka          |                                 |

## FUNKCJE

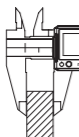

1

Średnica zewnętrzna

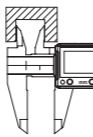

2

Średnica wewnętrzna



3

Głębokość

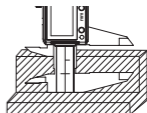

4

Wysokość

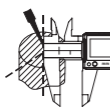

5

Trasowanie

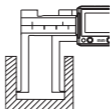

6

Średnica wewnętrzna  
(Limit CDO)

## WYMIANA BATERII

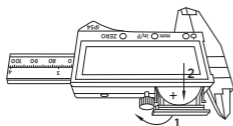

**Uwaga:** Jeśli suwmiarka ma być nie używana przez dłuższy czas, wyjąć baterię.

## WYSZUKIWANIE I USUWANIE USTEREK

Problem	Możliwe przyczyny	Rozwiązanie
Migające cyfry	Słaba bateria	Wymienić baterię
Brak wskazania	1. Słaba bateria 2. Słaby styk	1. Wymienić baterię 2. Oczyszczyć baterię i gniazdo baterii. Zwrócić uwagę by + był u góry
Brak zmiany wskazań	Przypadkowe problemy w układzie	Wyjąć baterię i założyć z powrotem po 2 minutach

## ÜLEVAADE

Digitaalsed nihikud suure vedelkristallekraaniga ja 13 mm numbritega. Lugemiskiirus 3,0 mõõtmist/sek. Roostevabast terasest korpusega. Absoluutne mõõtmine ja nullimise võimalus igas asendis. Mõõtetulemus millimeetrites või tollides. Kaasas on pöidlarullik ise paigaldamiseks. Sise- ja välismõõtmete, sügavuse ja kõrguse mõõtmiseks ning märkimiseks. Toodetud vastavalt DIN 862 nõuetele.

## OMADUSED

- Suur vedelkristallekraan 13 mm numbritega
- Karastatud roostevabast terasest
- Protsessori lugemiskiirus 3,0 mõõtmist/sek
- 4 mõõtmisfunktsiooni
- Mõõtühikud: mm, tollid ja tolli osad
- Nullitav igas asendis
- Kaasas on pöidlarullik (ise paigaldamiseks)
- DIN 862

## TEHNILISED ANDMED

Mudel	150 mm	200 mm	300 mm	10-150 mm
Resolutsioon	0,01 mm / 0,0005"			
Määramatus	0,02 mm	0,03 mm	0,04 mm	0,03 mm
Korratavus	±0,01 mm / 0,0005"			
Lugemiskiirus	3,0 mõõtmist/sek			
Töökoha temperatuur	0°C - 40°C	0°C - 40°C	0°C - 40°C	0°C - 40°C
Hoiukoha temperatuur	-20°C - 70°C	-20°C - 70°C	-20°C - 70°C	-20°C - 70°C
Töökoha õhuniiskus	<80%	<80%	<80%	<80%
Toide	1 × 3 V CR 2032 liitium, komplektis			

## POS

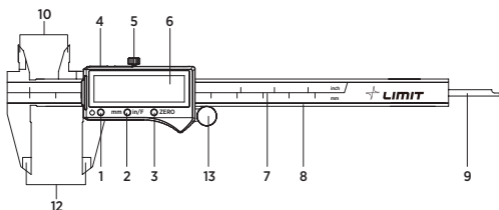

- |                        |                                 |
|------------------------|---------------------------------|
| 1. ON/OFF lüüti        | 8. Latt                         |
| 2. mm/tollid lüüti     | 9. Sügavusmõõtevarb             |
| 3. Nullimine           | 10. Sisemõõtmine                |
| 4. Patarei kaas        | 11. Kõrguse mõõtmine            |
| 5. Stopperkuvi         | 12. Välismõõtmine               |
| 6. Vedelkristallekraan | 13. Pöidlarullik (lisavõimalus) |
| 7. Skaala              |                                 |

## FUNKTSIOONID

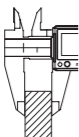

1  
Välimööde

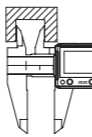

2  
Sisemööde



3  
Sügavus

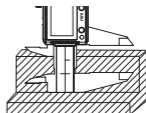

4  
Kõrgus

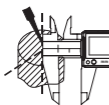

5  
Märkimine

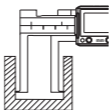

6  
Sisemööde  
(Limit CDO)

## PATAREI VAHETAMINE

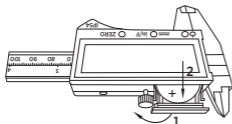

**Märkus:** Eemalda patarei, kui sa mõõteriista pikemat aega ei kasuta.

## VIGADE KÕRVALDAMINE

Probleem	Võimalikud põhjused	Lahendus
Numbrid vilguvad	Tühjenev patarei	Vaheta patarei välja
Tühi ekraan	1. Tühjenev patarei 2. Halb kontakt	1. Vaheta patarei välja 2. Puhasta patarei ja patareipesa. Kindlusta, et patarei + oleks ülalpool
Külmunud numbrid	Probleem elektriahelas	Võta patarei välja ja pane 2 minuti pärast tagasi

## APŽVALGA

Skaitmeninis slankmatis su dideliu skystųjų kristalų ekranu, kuriame rodomi 13 mm dydžio skaitmenys. Greitas nuskaitymas dėl 3,0 m/s atsako spartos. Nerūdijančiojo plieno skalės dalis. Absoliutusis matavimas ir nulio nustatymas, esant bet kokiai padėčiai, rodmenys pateikiami mm arba col. Komplekte yra rievėtas ratukas (reikia pritvirtinti patiems). Skirtas tiek vidiniam, tiek išoriniam skersmeniui, gyliui ir aukščiui matuoti, turi įrėžimo funkciją. Pagamintas pagal DIN 862.

## SAVYBĖS

- Didelis skystųjų kristalų ekranas, kuriame rodomi 13 mm dydžio skaitmenys
- Grūdintas nerūdijantis plienas
- Centrinio procesoriaus nuskaitymo sparta 3,0 m/s
- 4 matavimo funkcijos
- Matavimo vienetai: mm, col. & frakcija coliais
- Nulio nustatymas esant bet kokiai padėčiai
- Komplekte yra rievėtas ratukas (reikia pritvirtinti patiems)
- DIN 862

## TECHNINIAI DUOMENYS

Modelis	150 mm	200 mm	300 mm	10-150 mm
Skiriamoji geba	0,01 mm / 0,0005 col.			
Tikslumas	0,02 mm	0,03 mm	0,04 mm	0,03 mm
Pakartojamumas	±0,01 mm / 0,0005 col.			
Atsako sparta	3,0 m/s	3,0 m/s	3,0 m/s	3,0 m/s
Darbinė temperatūra	Nuo 0 iki 40°C	Nuo 0 iki 40°C	Nuo 0 iki 40°C	Nuo 0 iki 40°C
Laikymo temperatūra	Nuo -20 iki 70°C	Nuo -20 iki 70°C	Nuo -20 iki 70°C	Nuo -20 iki 70°C
Darbinė drėgmė	<80%	<80%	<80%	<80%
Maitinimo šaltinis	1×3 V CR 2032 ličio, yra komplekte			

## AŽVALGA

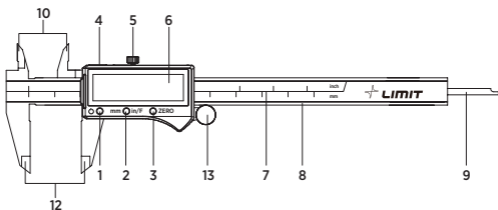

1. ĮJUNGIMO/IŠJUNGIMO jungiklis
2. mm/col. jungiklis
3. Nulio nustatymas
4. Maitinimo elemento dangtelis
5. Fiksavimo varžtas
6. Skystųjų kristalų ekranas
7. Skalė
8. Kotas
9. Gylio matavimo strypas
10. Vidinio skersmens matavimas
11. Aukščio matavimas
12. Išorinio skersmens matavimas
13. Rievėtas ratukas (pasirinktinis)

## FUNKCIJOS

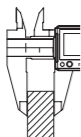

1

Išorinis skersmuo

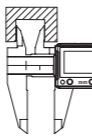

2

Vidinis skersmuo



3

Gylis

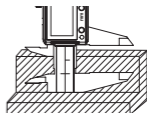

4

Aukštis

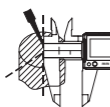

5

Įrėžimas

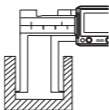

6

Vidinis skersmuo  
(Limit CDO)

## MAITINIMO ELEMENTO KEITIMAS

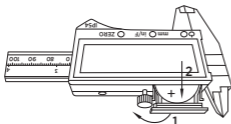

**Pastaba:** Jei slankmačio nenaudosite ilgą laiką, išimkite maitinimo elementą.

## TRIKČIŲ DIAGNOSTIKA

Problema	Galimos priežastys	Sprendimas
Mirksintys skaitmenys	Žema įtampa	Pakeiskite bateriją
Ekrane nieko nerodoma	1. Žema įtampa 2. Prastas kontaktas	1. Pakeiskite bateriją 2. Nuvalykite bateriją ir baterijos lizdą. Įsitinkinkite, kad + nukreiptas į viršų
Fiksuoti skaitmenys	Atsitiktinis gedimas grandinėje	Išimkite bateriją ir po 2 minučių ją pakeiskite

## PĀRSKATS

Digitāls bīdmērs ar lielu LCD displeju un 13 mm lieliem cipariem. Ātra nolasišana ar reakcijas laiku 3,0 m/s. Skalas daļa no nerūsoša tērauda. Absolūtais mērījums un nulles iestatījums jebkurā pozīcijā, nolasa mm vai collas. Iekļauts īkšķa ritenītis pašinstalācijai. Mēra gan iekšējo diametru, ārējo diametru, gan dziļumu un augstumu, ir gravēšanas funkcija. Ražots atbilstoši DIN 862.

## ĪPAŠĪBAS

- Liels LCD ar 13 mm cipariem
- Rūdīts nerūsošs tērauds
- CPU nolasišanas ātrums 3,0 m/s
- 4 funkciju mērījumi
- Mērvienības: mm un collas & collas daļskaitlis
- Nulles iestatījums jebkurā pozīcijā
- Iekļauts īkšķa ritenītis (pašinstalācijai).
- DIN 862

## TEHNISKIE DATI

Modelis	150 mm	200 mm	300 mm	10-150 mm
Izšķirtspēja	0,01 mm / 0,0005 collas			
Precizitāte	0,02 mm	0,03 mm	0,04 mm	0,03 mm
Atkārtojamība	±0,01 mm / 0,0005 collas			
Reakcijas laiks	3,0 m/s	3,0 m/s	3,0 m/s	3,0 m/s
Darba temperatūra	0°C - 40°C	0°C - 40°C	0°C - 40°C	0°C - 40°C
Glabāšanas temperatūra	-20°C - 70°C	-20°C - 70°C	-20°C - 70°C	-20°C - 70°C
Darba mitrums	<80%	<80%	<80%	<80%
Barošana	1×3 V CR 2032 Litija, ir iekļauta			

## POZĪCIJAS

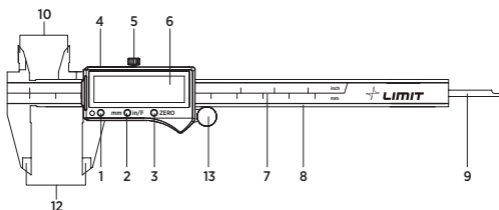

- |                                    |  |
|------------------------------------|--|
| 1. Ieslēgšanas/izslēgšanas slēdzis | 8. Stars                               |
| 2. mm/collu pārslēgš               | 9. Dziļuma mērstienis                  |
| 3. Nulles iestatījums              | 10. Iekšējā diametra mērījums          |
| 4. Baterijas vāciņš                | 11. Augstuma mērījums                  |
| 5. Fiksēšanas vāciņš               | 12. Ārējā diametra mērījums            |
| 6. Šķidro kristālu displejs (LCD)  | 13. Īkšķa ritenītis (papildaprīkojumā) |
| 7. Skala                           |  |



## FUNKCIJAS

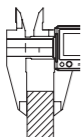

1

Ārējais diametrs

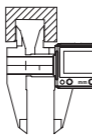

2

lekšējais diametrs



3

Dziļums

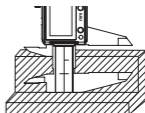

4

Augstums

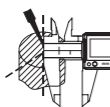

5

Gravēšana

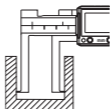

6

lekšējais diametrs  
(Limit CDO)

## BATERIJAS MAIŅA

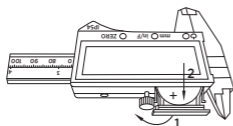

**Piezīme.** Izņemiet bateriju, ja ierīci neizmantojat ilgāku laiku.

## PROBLĒMU NOVĒRŠANA

Problēma	Iespējamie iemesli	Risinājums
Cipari mirgo	Zems spriegums	Nomainiet bateriju
Displejs nerāda	1. Zems spriegums 2. Slikts kontakts	1. Nomainiet bateriju 2. Notīriet bateriju un tās ligzdu. Nodrošiniet, ka + ir augšpusē
Cipari ir fiksēti	Problēmas ķēdē	Izņemiet bateriju un nomainiet to pēc 2 minūtēm







AB 60 mm  
LD 12 mm  
C1 55 mm

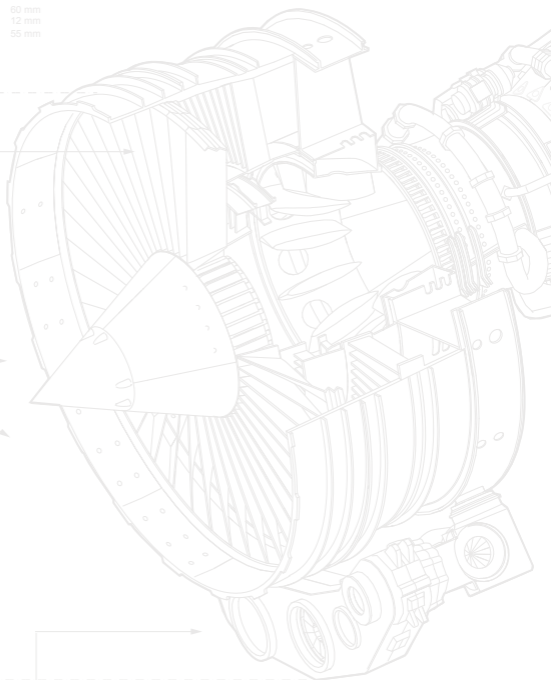

80/50



**LIMIT**  
Precision Made Easy

83/20

info@limit.se

limit-tools.com

+46 322-60 60 00